

GALAXY
VANS

LIMO

SHUTTLE

MOBILITY



 **Waldoch**
Luxury Vans & Off-Road Trucks

Waldoch is a nationwide RAM approved specialty vehicle manufacturer. We specialize in building unique packages to fit the lifestyle of each consumer.

PROMASTER

LUXURY CONVERSION VANS TO FIT YOUR PLEASURE

GALAXY
VANS



The Waldoch conversion van has changed dramatically over the years. Back in the 70's a disco ball, green shag carpet and some stained plywood finished a clean and quality conversion. Today wood grain is out and high quality is in, with French stitched ultra-leather, plush interior, vinyl wood flooring, multi-color LED lighting, and fold down TV screens larger than are in some homes. Our vans have a polished exterior with unique graphics, paint to match running boards. We remove every black textured plastic piece and paint it to compliment the overall clean and elegant look. Our top of the line Galaxy Van package features color keyed side moldings, bumper insert fog lights and all trim pieces painted for a polished and elegant look.

Premium seating features leather fully adjustable captain's chairs with added comfort like power lumbar power recline and heat for lasting comfort. A fully automatic rear bench that reclines to a bed is a great feature for those impromptu rest stops on a long road trip. At each passenger seat enjoy all the comforts and conveniences you would expect from a Waldoch van like USB charging ports, individual passenger lighting and climate control venting. Close all the shades and use the LED mood lighting to enhance the cinema experience provided by an LCD display and surround sound TV that flips down out of the headliner 32" large and LED 1080P screen.

WALDOCH PROMASTER HIGH TOP 7-9 PASSENGER

GALAXY
VANS

STANDARD FEATURES

STANDARD FEATURES

- ✔ Full View Factory Windows (van ordered with this option)
- ✔ Compliance System (Seating & Belts)
- ✔ Sound Deadening R11 Insulation Throughout
- ✔ Moisture Resistant WISE Insulated Flooring
- ✔ Plush Nylon Carpeting Throughout with 1/2" Carpet Pad
- ✔ Front Door Armrest Pad
- ✔ French Stitched Soft Touch Sidewalls w/Coverings to Match Décor
- ✔ Vinyl Wall and Door Coverings in Rear Storage
- ✔ Automotive Luxury Foamed Fabric Ceiling Throughout
- ✔ Webasto Rear Air/Heat w/Venting in the Rear Facing Forward - Front controlled
- ✔ Roller Shade at Each Window
- ✔ Overhead Storage Large Enough to fit 48" in Length

AMENITIES

- ✔ Stainless Steel LED Beverage Holders
- ✔ Retractable Flush Mount Clothes Hangers in Cargo Area
- ✔ Entry Assist Handles
- ✔ Color Keyed Floor Mat Set Throughout
- ✔ First Aid Kit
- ✔ Fire Extinguisher
- ✔ 4 Large Air Vent in the Rear
- ✔ Rear Entry Handles
- ✔ Owner's Packet in Waldoch Accessory Bag

EXTERIOR ENHANCEMENTS

- ✔ Color Keyed Wheel to Wheel Fiberglass Pony Running Boards
- ✔ Custom Designed Waldoch Vinyl Graphics - High Top and Middle
- ✔ Galaxy Chrome Exterior Insignias
- ✔ Color Keyed all Body Panels, Front & Rear Bumper, Textured Parts

STANDARD ELECTRONICS

- ✔ Driver Command and Control Center
- ✔ Automotive Customized Electrical System
- ✔ Automotive Design Wiring Harness
- ✔ Personal Overhead Reading Light
- ✔ Personal Control Center w/ USB Charging Port & Switch for LED Light
- ✔ Soft Glow Indirect LED Accent Lighting - Window Headers & Ceiling & Personal Pockets
- ✔ Courtesy LED Light in Side Step Wells and Sliding Door
- ✔ Blue LED Accent Lighting
- ✔ Convenient Passenger USB Power Point
- ✔ 12 Volt Power Points (2) Front & Rear

SEATING FOR 7 PASSENGER

- ✔ 3 Pt. Seat Belts on all Midrow Seats: 20.5" wide by 28" tall
- ✔ Maybach Seats Swivel & Lock in Forward Position
- ✔ Maybach Bucket Seats w/Hard Skirts- Quick Release Center
- ✔ Re-Upholstered OE Front Seats
- ✔ Child Seat Ready
- ✔ Seats with Slide Track with Towel Bar style handle
- ✔ Quick Release Sofa 56" wide with Manual Recline and Slide
- ✔ Sofa Folds into a Bed 56" wide x 58" Long
- ✔ Add-A-Back on Rear Sofa to extend for Bed or Self

**Nine Passenger Van Requires 2 Bucket Seats*

***Eight Passenger removed sofa with 2 Bucket seats*

WOOD TRIM HYDRO/CLEAR COAT

- ✔ Dash Center
- ✔ Front Door Accents
- ✔ Upper Storage Doors



WALDOCH PROMASTER HIGH TOP

7-9 PASSENGER



LAYOUTS

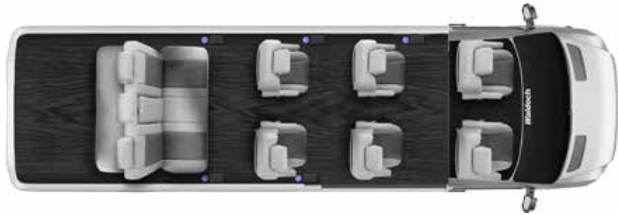

159" EXTENDED
9 PASSENGER
LUXURY

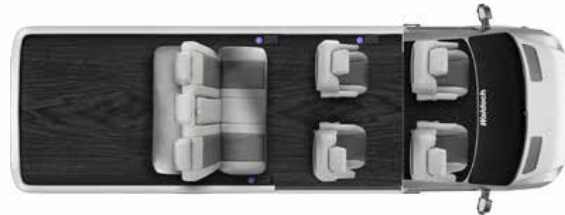

159"
7 PASSENGER
REAR STORAGE



159"
9 PASSENGER
LUXURY

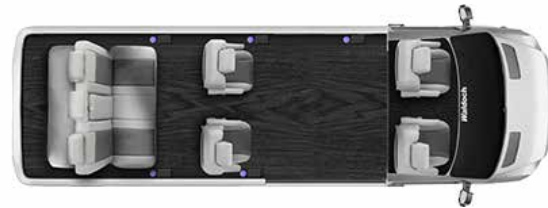

159"
7 PASSENGER

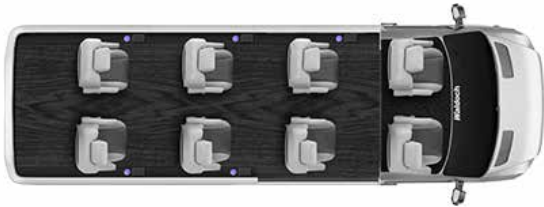

159"
8 PASSENGER
LUXURY



136"
5 PASSENGER
MOBILITY

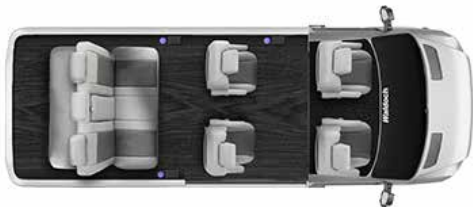

136"
7 PASSENGER
LUXURY

WALDOCH PROMASTER HIGH TOP

7-9 PASSENGER



OPTIONAL EQUIPMENT

EVOLUTION PACKAGE *(*Included this package)*

- * Power Hidden Shade System- switch at each available window
- * LED Glow Lighting on Driver and Passenger Sides
- * Painted Center Grill or Chrome
- * Front Fog Light Built into Front Bumper
- * Painted Mirrors
- * Audio Surround Sound System with Sub-Woofer for Entertainment System
- * Ultra Soft Leather Seating Upgrade
- * Add Power Slide and Power Recline to Sofa
- * Heated Front Seats with High and Low Switch

INTERIOR

- Altro Wood Smooth Acoustic Floor - Tan
- Altro Wood Smooth Acoustic Floor - Brown
- Altro Wood Smooth Acoustic Floor - Gray
- Center Table with Two Cup Holders: Removable Two Locations
- Center Console Cooler 12volt Cooler / Warmer Portable throughout van
- Presidential Seating Package - 6 Bucket seats Deleting the Rear Sofa
- Second Row Power Leg Bucket Seats - "Requires more Legroom" (recommends 7 Seater on 148 Van) (no Swivel) (no Quick Release)
- Lock Box - Under Sofa or in Rear Area
- Upgraded Rear Heat & Air System - Second Condenser & Compressor (larger air for southern States)
- 3PT Power Bucket Rear Sofa (Not Quick Release)

EXTERIOR

- Power Side Step on Sliding Passenger Door Only
- Tint Front Two Windows

WHEELS AND TIRES

- 16" Custom Wheels on Factory Tires
- 17" Custom Wheels on Goodyear Tires

ELECTRONICS

- 32" Power Down HD LCD TV with DVD and HDMI - Game Ready for gaming systems - 1000 Watt Inverter
- Mobile Satellite DirectTV (Customer Activation Required) - No HD Channels
- Apple TV (requires Customer Provided WIFI Connection)
- Homelink Garage Door Opener
- WIFI mobile - Verizon or AT&T (monthly service cost) Connects to open Networks
- 110 Volt Plug with Inverter at Four Seats - 1000 Watt Inverter (Separate Plug on Wall)
- Smart Battery Converter Charging system with quick connect - plugs in for Powering Waldoch Conversion

MOBILITY

Please contact Billy Waldoch 651-287-9639 - All Personal Use Mobility is done by outside Mobility Service Centers
 Lift Added-Retail Mobility Ricon Clearway Wheelchair Side Lift 800lbs with Q'straint Tie Down w/slide 'N Click (pucks) Retractable shoulder/Lap

ELAN PACKAGE **Includes below Features*

- Ultra Soft Leather Seating Upgrade
- 16" Custom Wheels on Factory Tires
- 32" Power Down HD LCD TV with DVD and HDMI - Game Ready for gaming systems - 1000 Watt Inverter

ASCENT PACKAGE **Includes below Features*

- Ultra Soft Leather Seating Upgrade
- Add Power Slide and Power Recline to Sofa
- Altro Wood Smooth Acoustic Floor -- Tan - Brown - Gray
- 16" Custom Wheels on Factory Tires
- 32" Power Down HD LCD TV with DVD and HDMI - Game Ready for gaming systems - 400 Watt Inverter
- 110 Volt Plug with Inverter at Four Seats - 700 Watt Inverter (separate plug on wall)
- Power Hidden Shade System- switch at each available window

SUMMIT PACKAGE **Includes below Features*

- Evolution Package
- 32" Power Down HD LCD TV with DVD and HDMI - Game Ready for gaming systems - 400 Watt Inverter
- 17" Custom Wheels on Goodyear Tire
- Altro Wood Smooth Acoustic Floor - Tan - Brown - Gray
- Center Table with Two Cup Holders: Removable Two Locations
- 110 Volt Plug with Inverter at Four Seats - 700 Watt Inverter (separate plug on wall)



WALDOCH GALAXY PROMASTER MEDIUM ROOF | 7-9 PASSENGER



SIZINGS

159"
JUMBO EXTENDED

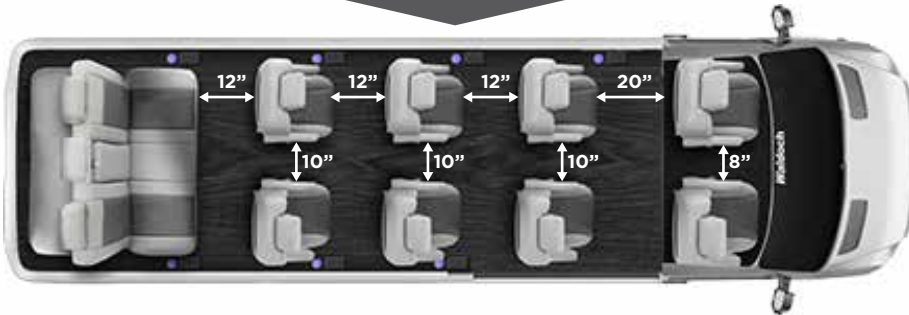

159"

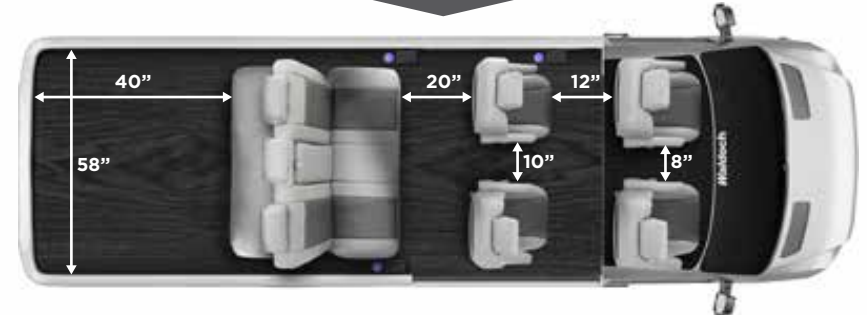

159"

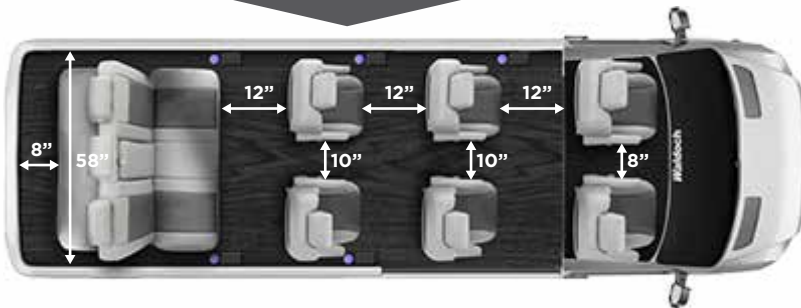

159"

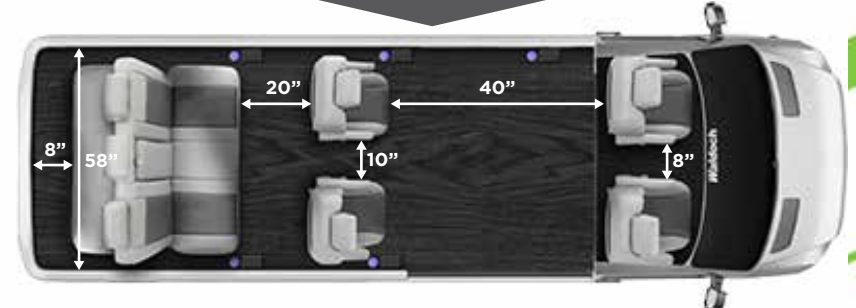

WALDOCH GALAXY PROMASTER MEDIUM ROOF | 7-9 PASSENGER



LIMO CONVERSION

Waldoch has been building luxury Conversion van for over 40 years and has been building LIMO's for about 15 years. Waldoch just thought it was a good fit with building person use vehicles and Travel vans it just fits. Waldoch builds on two models the Ford Transit and the Ram Promaster, they work great on limo buses vans.

The Ram Promaster we build on the 159 High Roof van, with 77" of head room and 172.2" of floor space front to back. The Exterior height is 108.6" tall to make sure you can go placing you are planning on traveling. Executive coach Limo are perfect for Weddings, Tailgate parties to go to the game, Dinner Parties, Special Events and much more. Waldoch has many different floor plan layouts for the Ford Transit Van some of the number 1 floor plans are Party Limo 10 Passenger, Limo Lounge 15 Passenger, Limo 9-10 Passenger, Wedding Limo 15+ and more just ask a sale rep. With our Black on Black design interior with Huge 40" TV's with LED 1080P picture where you can watch cable going down the road these are some of the best Limo manufactured anywhere. Waldoch Limo Builds are match to the highest quality and stand alone with the options and features you can get with this Limo Manufacture.



- High Quality long lasting Products
- All 12 Volt Products no Invertors (TV's, DVD everything 12 volt)
- 40 Years in the Conversion Van Shuttle Luxury builder market
- Innovative products
- Power Shades & Manual Shades
- First Class Executive vans for personal business people



WALDOCH LIMO PROMASTER

STANDARD FEATURES



OPTIONAL
FEATURE



STANDARD FEATURES

- ✔ Full View Factory Windows (van ordered with this option)
- ✔ Compliance System (Seating & Belts)
- ✔ Sound Deadening R11 Insulation Throughout
- ✔ Moisture Resistant WISE Insulated Flooring
- ✔ Altro Flooring Vinyl made to look like Hard Wood Floors
- ✔ Front Door Armrest Pad
- ✔ French Stitched Soft Touch Sidewalls w/Coverings to Match Décor
- ✔ Vinyl Wall and Door Coverings in Rear Storage
- ✔ Automotive Luxury Foamed Fabric Ceiling Throughout
- ✔ Webasto Rear Air/Heat w/Venting in the Rear Facing Forward Rear Controlled
- ✔ Roller Shade at Each Window

EXTERIOR ENHANCEMENTS

- ✔ Color Keyed Wheel to Wheel Fiberglass Pony Running Boards
- ✔ Galaxy Chrome Exterior Insignias

AMENITIES

- ✔ Stainless Steel LED Beverage Holders
- ✔ Retractable Flush Mount Clothes Hangers in Cargo Area
- ✔ Entry Assist Handles
- ✔ Color Keyed Floor Mat Set Throughout
- ✔ First Aid Kit
- ✔ Fire Extinguisher
- ✔ Large Air Vent in the Rear
- ✔ Rear Entry Handles
- ✔ Owner's Packet in Waldoch Accessory Bag

STANDARD ELECTRONICS

- ✔ Driver Command and Control Center
- ✔ Automotive Customized Electrical System
- ✔ Automotive Design Wiring Harness
- ✔ Personal Overhead Reading Light
- ✔ Personal Control Center w/ USB Charging Port & Switch for LED Light
- ✔ Soft Glow Indirect LED Accent Lighting - Window Headers
- ✔ Courtesy LED Light in Side Step Wells and Sliding Door
- ✔ Blue LED Accent Lighting
- ✔ Convenient Passenger USB Power Point
- ✔ 12 Volt Power Points (2) Front & Rear

WOOD TRIM HYDRO /CLEAR COAT

- ✔ Woodgrain Accents - Optional Pick Hydro Trim Color

SEATING FOR 10 PASSENGER

- ✔ 3 Pt. Seat Belts on all Midrow Seats: 20.5" wide by 28" tall
- ✔ Maybach Seats Swivel & Lock in Forward Position
- ✔ Maybach Bucket Seats - Quick Release Center
- ✔ Re-Upholstered OE Front Seats
- ✔ Child Seat Ready
- ✔ Seats with Slide Track with Towel Bar style handle
- ✔ Quick Release Sofa 56" wide with Manual Recline and Slide
- ✔ Sofa Folds into a Bed 56" wide x 58" Long
- ✔ Add-A-Back on Rear Sofa to extend for Bed or Self

**See options below for alternate seating. Price can change.*

OPTIONAL
FEATURE



OPTIONAL
FEATURE



WALDOCH LIMO PROMASTER



LAYOUTS

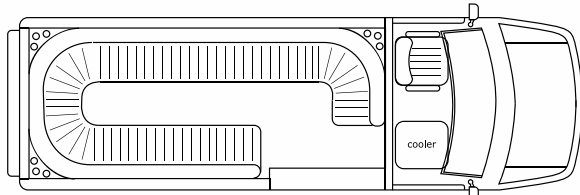

159" EXTENDED
15 PASSENGER
WEDDING LIMO

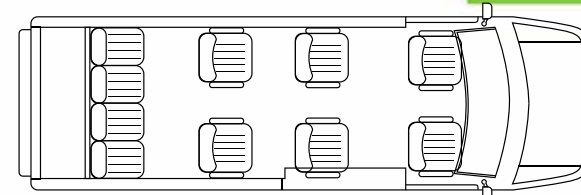

159" EXTENDED
10 PASSENGER
LIMO

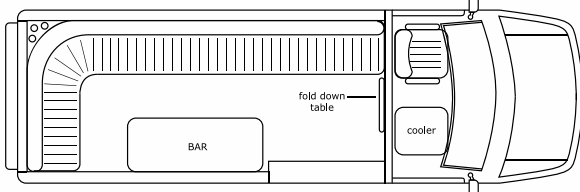

159" EXTENDED
15 PASSENGER
LIMO LOUNGE

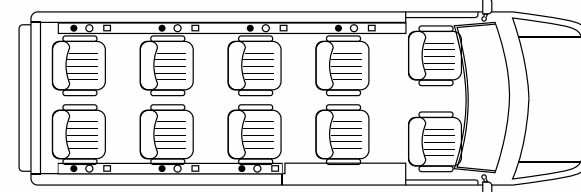

159" EXTENDED
10 PASSENGER
EXECUTIVE

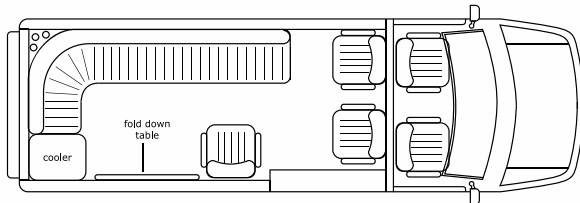

159" EXTENDED
10 PASSENGER
PARTY LIMO

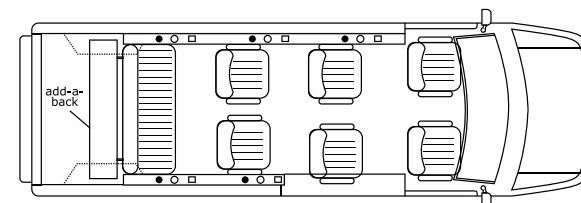

159" EXTENDED
9 PASSENGER
LUXURY

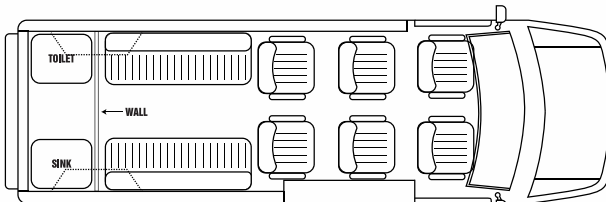

159" EXTENDED
6 PASSENGER
2 SOFA LIMO

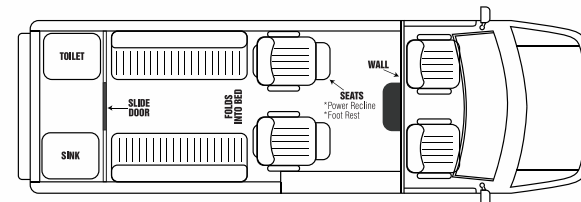

159" EXTENDED
4 PASSENGER
2 SOFA LIMO

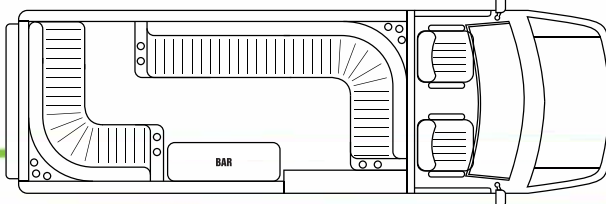

159" EXTENDED
15 PASSENGER
LIMO

WALDOCH LIMO PROMASTER



OPTIONAL EQUIPMENT

EVOLUTION PACKAGE *(*Included this package)*

- *Power Hidden Shade System- switch at each available window & 110V Outlets (3) 1000 Watt Inverter
- *LED Glow Lighting on Driver and Passenger Sides
- *Painted Center Grill
- *Audio Surround Sound System with Sub-Woofer for Entertainment System
- *Ultra Soft Leather Seating Upgrade
- *Add Power Slide and Power Recline to Sofa
- *Heated Front Seats with High and Low Switch

WHEELS AND TIRES

- 16" Custom Wheels on Factory Tires
- 17" Custom Wheels on Goodyear Tires

EXTERIOR

- Power Side Step on Sliding Passenger Door Only
- Tint Front Two Windows
- Color Keyed Exterior Textured Factory Panels-Smooth

INTERIOR

- Center Table with Two Cup Holders: Removable Two Locations
- Partition Wall - Dual Glass/Solid with 40" TV - Game Ready for Wii, PS4 or Xbox - 300 Watt Inverter
- Center Console Cooler 12volt Cooler / Warmer Portable throughout van
- RV Roof Top Air System - Shorepower Included (only works with Generator or shore power plug)
- Lock Box - Under Sofa or in Rear Area
- Second Row Power Leg Bucket Seats - "Requires more Legroom" (recommends 7 Seater on 148 Van)(no Swivel) (no Quick Release)
- Jet Desk 5 Tables at Seat to pull out of wall
- Upgraded Rear Heat & Air System - Second Condenser & Compressor (larger air for southern States)
- Jet Desk Table Driver Side Front
- Carpet - Delete Wood Floor

ELECTRONICS

- 32" Power Down HD LCD TV with DVD - Game Ready for gaming systems - 110V Outlets (4) - 1000 Watt Inverter
- Mobile Satellite DirectTV (Customer Activation Required) - No HD Channels
- Apple TV (requires Customer Provided Wifi Connection)
- WIFI mobile - Verizon or AT&T (monthly service cost) Connects to open Networks
- Homelink Garage Door Opener
- Rear Wall with Forward Facing 40" TV
- Tailgate TV Package with Rear Entertainment - 40"
- Floor Cooler System Under Rear Sofa Seat - 3 Bucket Seat (non Removeable or power)



SHUTTLE PROMASTER

SHUTTLE



Ram Promaster Shuttle Bus is a nice option, it is 6" lower to the ground than the Ford Transit and Front Wheel drive. The Promaster comes in one height and has a lot of head room for walking in and out. Shuttle Promasters work in many different applications, Churches, Wheelchairs, Specialist custom vans, Handicap Shuttle buses, Tour Buses shuttles and many more. From 10 Passenger Conversion Shuttles Promasters, 11 Passenger Luxury Shuttle vans, 12 Passenger Shuttle Buses, 13 Passenger Airport Shuttle Buses, 14-15 Custom Shuttles. The Promaster ram van came out in late 2014 and has been growing every year. More and more people will see the Ram Promaster as the U.S. Post office is using the Promaster for their new delivery vehicle all over American. Making the Ram Promaster the American Conversion Van. Waldoch is a Conversion Van Manufacture and has been for over 40 years, partnering with GM, Ford and Ram. Waldoch is a NTEA MVP for the Ram Promaster.

- Heavy Duty Altro Commercial Flooring
- Webasto Rear Heat & Air Conditioning with overhead venting
- Insulation throughout the van giving it great sounds deadening
- High durable Plastic walls
- Available Power Side Step Passenger Only (16" wide)
- Available Power Sliding Door Passenger Side only
- Available Leather upgrade to the seating
- Available High back bucket seating

WALDOCH SHUTTLE PROMASTER

8-15 PASSENGER

SHUTTLE

STANDARD FEATURES

STANDARD FEATURES

- ✔ Full View Factory Windows (van ordered with options)
- ✔ Altro Wood Smooth Acoustic - Gray
- ✔ Automotive Composite one Piece Walls & Headliner Throughout
- ✔ Rear Storage Area
- ✔ Webasto Rear Heat and Air Conditioning w/ Overhead Venting

STANDARD ELECTRONICS

- ✔ Two LED Overhead Lights -Powered by Door Switch
- ✔ Overhead Center LED light - Powered By Driver Switch

SAFETY FEATURES

- ✔ Fire Extinguisher (Rear)
- ✔ First Aid Kit

DELUXE TRANSIT DESIGN SEATING

- ✔ 12 Passenger - Ten Deluxe Cloth Seats w/Built-In Seat Belts: One Jump seat, One Single Seat, Two Double Seats, Two Double Four Seats 16" wide X 25" tall - D.5006
- ✔ 15 Passenger - Thirteen Deluxe Cloth Seats w/Built-In Seat Belts: One Jump seat, Two Single Seats, Three Double Seats, Two Double Four Seats 16" wide X 25" tall - D.5005

OPTIONAL
FEATURE



OPTIONAL
FEATURE



STANDARD
FEATURE



STANDARD
FEATURE



WALDOCH SHUTTLE PROMASTER

8-15 PASSENGER

SHUTTLE

LAYOUTS

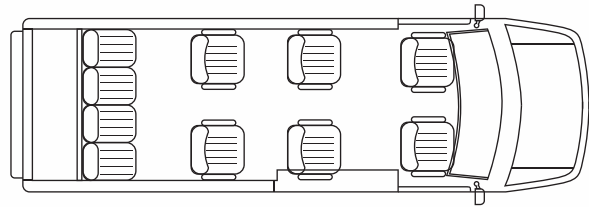

159"
10 PASSENGER
SHUTTLE

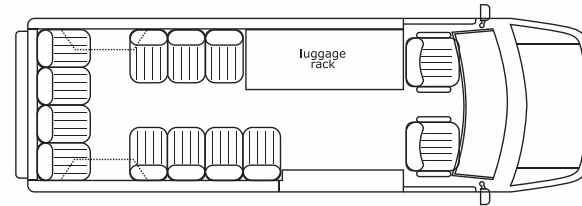

159"
13 PASSENGER
SHUTTLE

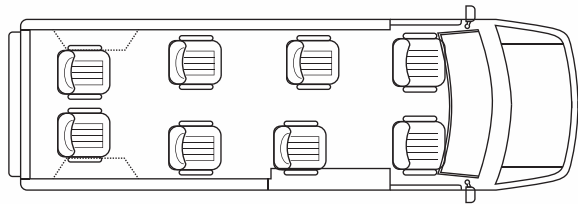

159"
8 PASSENGER
SHUTTLE

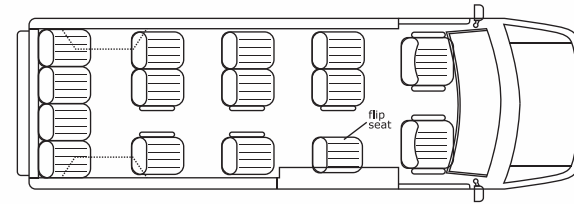

159"
15 PASSENGER
SHUTTLE

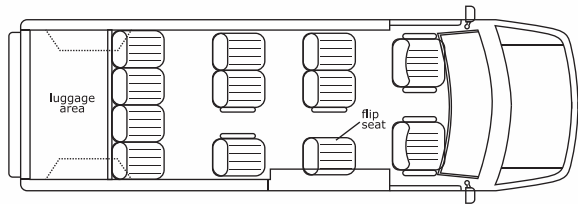

159"
12 PASSENGER
SHUTTLE

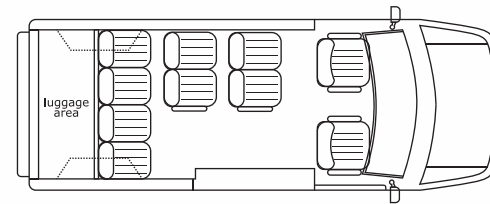

136"
10 PASSENGER
SHUTTLE

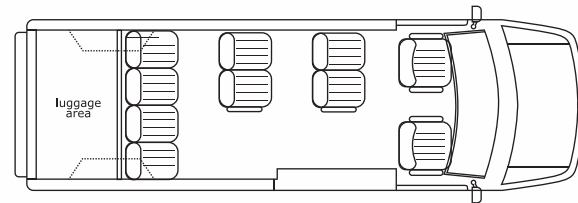

159"
10 PASSENGER
SHUTTLE

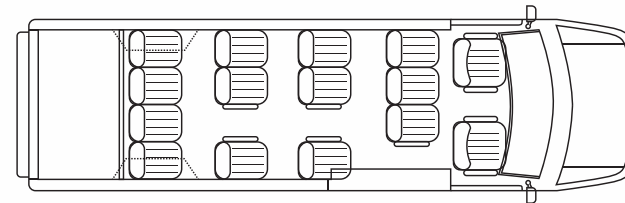

159" EXTENDED
15 PASSENGER
SHUTTLE

WALDOCH SHUTTLE PROMASTER

8-15 PASSENGER

SHUTTLE

OPTIONAL EQUIPMENT

ELECTRONICS

- 22" Flip-Down LCD Monitor w/DVD and Headphones
- Factory Speaker Upgrade Add Rear Speakers
- WIFI mobile - Verizon or ATT (monthly service cost)

EXTERIOR

- Black Aluminum Running Boards Short Driver & Long Passenger
- 159 EXT Upgrade Size of Van (VF3L27)
- Color Keyed Wheel to Wheel Fiberglass Pony Running Boards
- Exterior Paint on Side Moldings
- Power Side Step Passenger Door Only
- Window Tint - Front Two Windows
- Window Tint - All Windows

INTERIOR

- Rear Luggage Partition Half Wall (LED Light in Rear Storage)
- Soft Touch Lower Walls with USB Charging Ports (4) 12V (2)
- Sound Deadening Insulation Throughout Walls and Doors

SEATING

- Ultra Soft Leather Upgrade Package
- High Black Plush Leather Shuttle Seats 16" wide x 30" tall
- Vinyl Seating Upgrade Package



MOBILITY CONVERSION

MOBILITY

The Galaxy vans and the Waldoch Shuttle buses and Limo can have a handicap wheelchair put in any one of the 3 models waldoch manufactures. Starting with the Galaxy Promaster Conversion van, you take of the first row of seating and the mobility lift mounts right at the door. The Waldoch Mobility vans can be put in the side or the rear door. Waldoch works with mobility installers all over American, if you have a mobility company you are working with and would like to get a full size van. Give us a call and we will help you get the van of your dreams and keep your mobility company right in your home town. They know you the best with the different service needs you might have over the year. Waldoch does have a local installer that they work with if you don't have one you are working with. Handicap full size conversion vans can be a lot to take on that is why we have a proven way we have done it and its leaving the customer with a smile. Handicap vans can have the B&D transfer seats that will allow the seat to come back and pick the person up to move them in position if it's not easy to get into the driver or passenger seat. We also offer the ability to lock your wheel chair right in the passenger or driver position of the vehicle. It's called the EZ lock system. Simply push a button to release and you are set. The Q'straint tie down is our most popular and cost effective way to hold down the wheel chair, you do need a second person to help tie the person in the wheel chair or motorized chair down. The hand controls for the wheelchair and handicap vans is the best way for you to be in the driver seat and brake and gas with your hands, not having to worry about the pedals below. the Handicap steering wheel knob is a great way so you don't have to have 2 hands on the wheel while brake or accelerator.

- Working with any mobility installer in the US - American
- Understand the need and wants of the customer with ease of use in mind.
- Works with all different mobility lift companies
- Manufactures person use handicap and mobility van
- Manufactures commercial handicap and mobility shuttle vans



WALDOCH MOBILITY PROMASTER



STANDARD FEATURES

STANDARD FEATURES

- ✔ Full View Factory Windows (van ordered with options)
- ✔ Altro Wood Smooth Acoustic - Gray
- ✔ Automotive Composite one piece Headliner Throughout
- ✔ Rear Storage Area
- ✔ Webasto Rear Heat and Air Conditioning w/ Overhead Venting

DELUXE SHUTTLE DESIGN SEATING (Not included in open floor plan)

- ✔ High Traffic Grey Vinyl Seating Standard as seen in the Floor Plans
- ✔ Open Floor Plans do not include seating, Must pick options**
- ✔ Hand Rails Stainless Right and Left Side Siding Door opening

MOBILITY (Not included in open floor plan)

- ✔ Braun Millennium 800 LB. 34"X51" - Commercial use
- ✔ Qstraint Slide N' Click Kit's
- ✔ Interlock System
- ✔ Q-Straint Bags (2) Mount on Rear Driver Wall

SAFETY FEATURES

- ✔ Fire Extinguisher
- ✔ First Aid Kit



OPTIONAL
FEATURE



OPTIONAL
FEATURE



OPTIONAL
FEATURE



OPTIONAL
FEATURE



MOBILITY

WALDOCH MOBILITY PROMASTER

MOBILITY

LAYOUTS

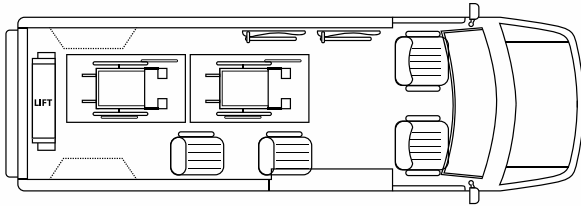

159" LIFT
8 PASSENGER
2 WHEEL CHAIRS

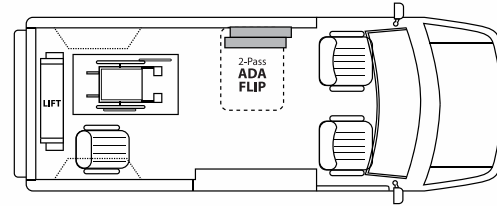

136" REAR LIFT
5 PASSENGER
1 WHEEL CHAIR

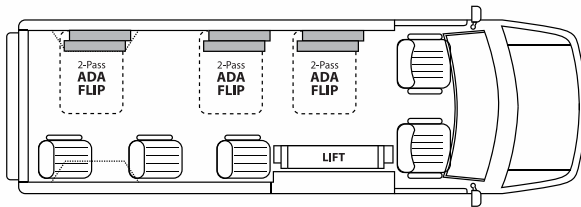

159" SIDE LIFT
11 PASSENGER
3 WHEEL CHAIRS

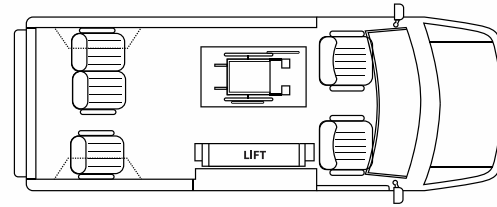

136" SIDE LIFT
5 PASSENGER
1 WHEEL CHAIR

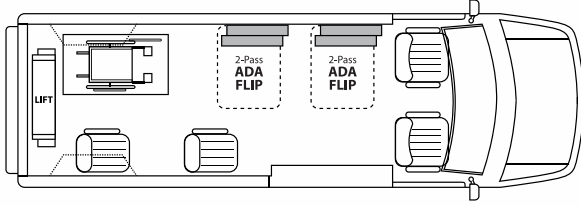

159" REAR LIFT
8 PASSENGER
3 WHEEL CHAIRS

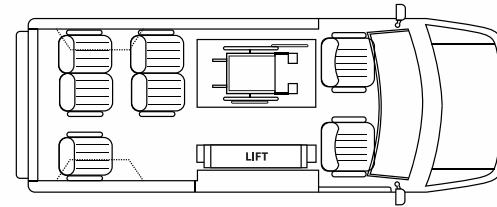

136" SIDE LIFT
7 PASSENGER
1 WHEEL CHAIR

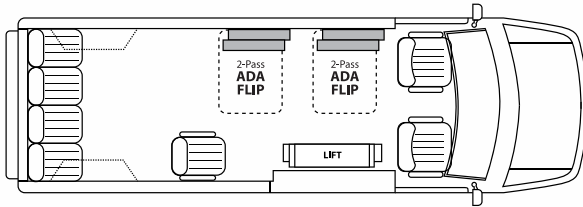

159"
11 PASSENGER
3 WHEEL CHAIRS

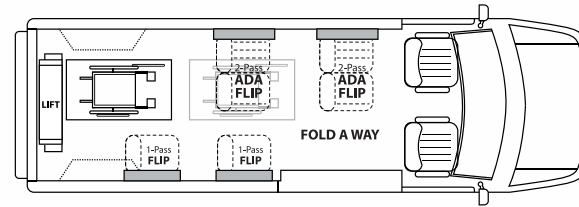

159" REAR LIFT
8 PASSENGER
2 WHEEL CHAIR

WALDOCH MOBILITY PROMASTER



LAYOUTS

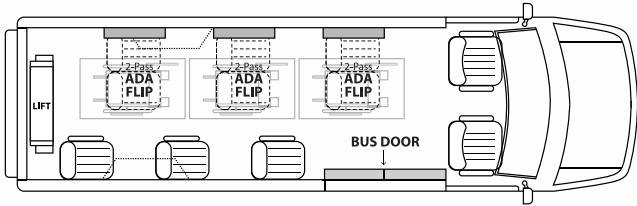

159" EXT
REAR LIFT
11 PASSENGER
3 WHEEL CHAIR

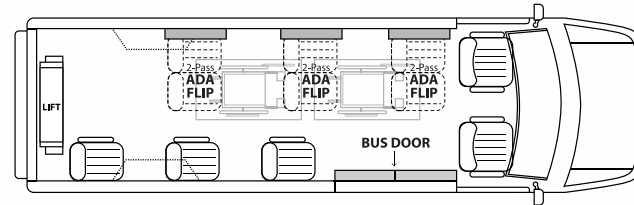

159" EXT
REAR LIFT
11 PASSENGER
2 WHEEL CHAIR

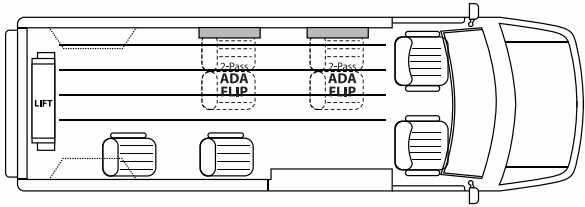

159" REAR LIFT
8 PASSENGER

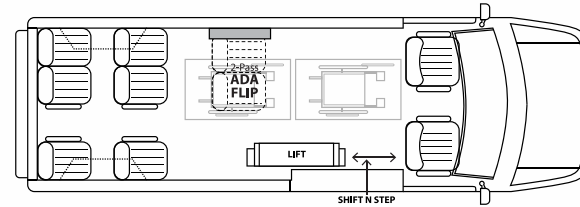

159" SIDE LIFT
10 PASSENGER
4 WHEEL CHAIR

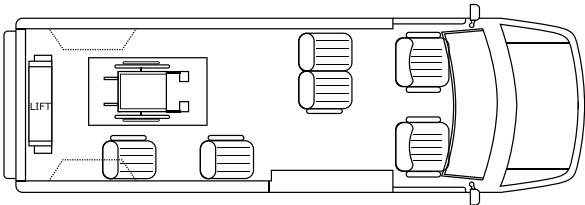

159" REAR LIFT
6 PASSENGER
1 WHEEL CHAIR

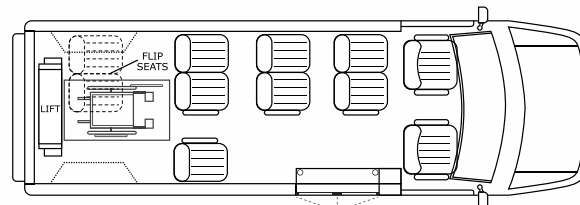

159" REAR LIFT
11 PASSENGER
1 WHEEL CHAIR

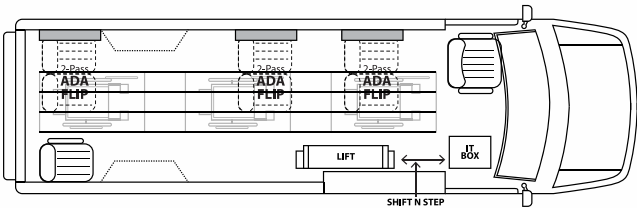

159" EXT
SIDE LIFT
8 PASSENGER
3 WHEEL CHAIR

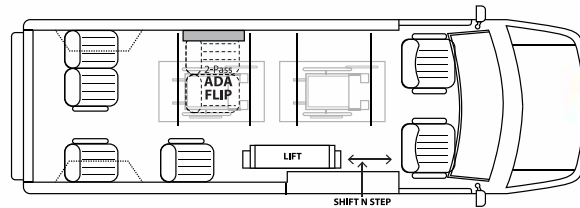

159" SIDE LIFT
8 PASSENGER
2 WHEEL CHAIR

WALDOCH MOBILITY PROMASTER

MOBILITY

OPTIONAL FEATURES

ELECTRONICS

- 22" Flip-Down LCD Monitor w/DVD and Headphones
- Factory Speaker Upgrade Add Rear Speakers

MOBILITY LIFT

- Braun Millennium 800 LB. 34" X51" usable platform - Commercial use - Rear Entry
- Braun Millennium 800 LB. 34" X51" usable platform - Commercial use - Side Entry
- Braun Century 1000LB. 34"x51" usable platform - Commercial use - Rear Entry

TIE DOWN

- Qstraint L-Track Kit (4) Retractors (1) Retractable lap Shoulder Belt (4) L- Tracks 15"
- Qstraint Slide N' Click Kit (4) Retractors (1) Retractable lap shoulder belt (4) Slide Bottom
- QRT 360 Tie Down w/Slide 'N Click (puck) Retractable Shoulder/Lap (bags mounted on wall)

INTERIOR

- Hand Rails Stainless Right and Left Side Sliding Door opening
- Hand Rail stainless Right side passenger Sliding Door opening
- Insulation Package all size Vans Walls & Headliner
- Upgraded Rear Heat & Air System - Second Condenser & Compressor
- Pro Air Rear Heat Only for Door opening (Cold weather)

EXTERIOR

- Color Keyed Wheel to Wheel Fiberglass Pony Running Boards
- Exterior Paint on Side Moldings
- Power Side Step on Sliding Passenger Door Only
- Grip Driver and Passenger Side Step 7" width Black Aluminum Finish
- Grip Passenger Only Side Step 7" width Aluminum Finish
- Window Tint - Front Two Windows
- Window Tint - All Windows

SEATING

- Ultra Soft Leather Upgrade Package
- High Back Plush Leather Shuttle Seats 16" wide x 30" tall
- Vinyl Seating Upgrade Package
- Single Seat Cloth 18" Wide X 30" Long (Put number in box for open floor plan)
- Double Seat Cloth 35" w X 30" Long (Put number in box for open floor plan)
- Flip Single Seat Cloth 18" w X 25" Lg Seated - Flip 13" (Put number in box for open floor plan)
- Fold-a-way Double Seat Cloth 36" w X 25" Lg (Put number in box for open floor plan)



WALDOCH MOBILITY PROMASTER



SIZINGS

159"

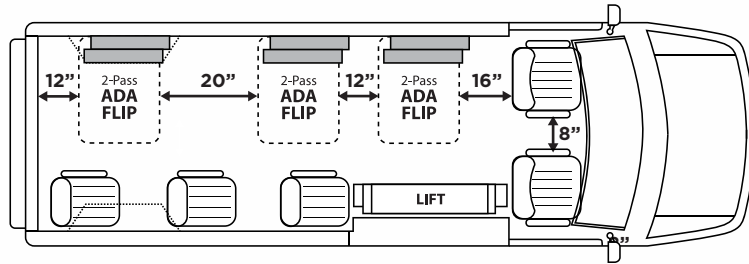

159"

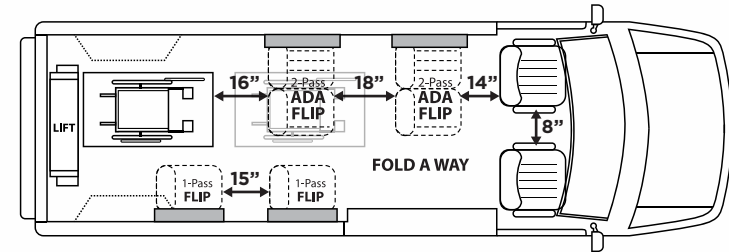

136"

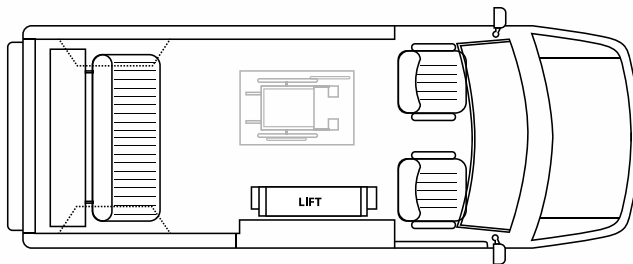

136"

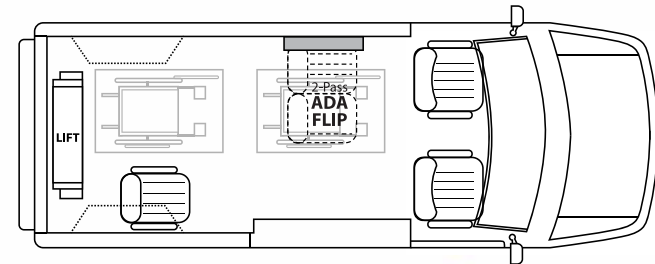

WALDOCH VAN COLOR AND TRIM OPTIONS

EXTERIOR COLORS

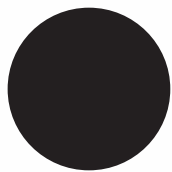

SHADOW BLACK
(G1)

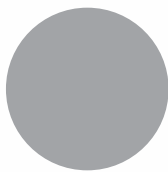

INGOT SILVER
(UX)

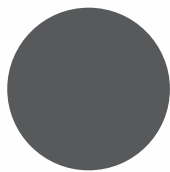

STONE GRAY
(D1)

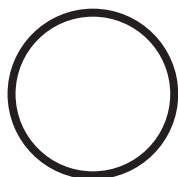

OXFORD WHITE
(YZ)

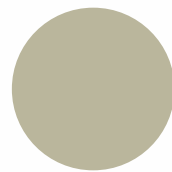

WHITE GOLD
(GN)

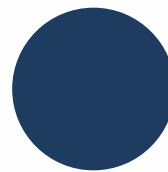

BLUE JEAN
(N1)

SEATING

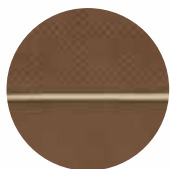

LATTE WITH
CREAM
PIPING



STEERHIDE
WITH BLACK
PIPING



BLACK WITH
PEWTER
PIPING

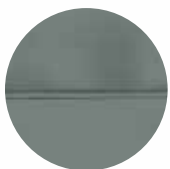

QUICKSILVER
WITH MEDIUM
ALABASTER



PEWTER
WITH BLACK
PIPING

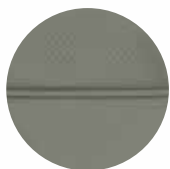

MEDIUM
NEUTRAL
(TAN) WITH
M. NEUTRAL
PIPING

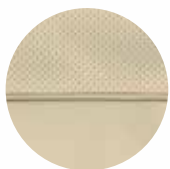

CREAM WITH
CHAMOIS
PIPING

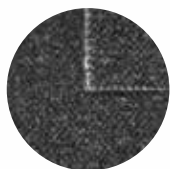

BLACK
CLOTH



TAN
CLOTH

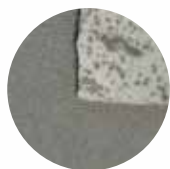

GRAY
CLOTH

FLOORING



TAN WOOD
VINYL
FLOOR

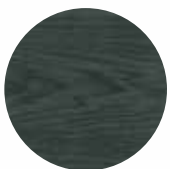

GRAY WOOD
VINYL
FLOOR



BROWN
WOOD
VINYL FLOOR



TAN
CARPET



BLACK
CARPET

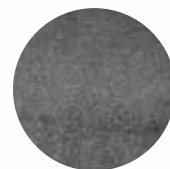

GRAY
CARPET

VAN TRIM

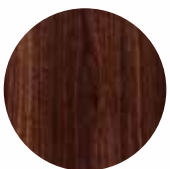

WALNUT
WOOD
WTP-105



STRAIGHT
GRAIN GRAY
WTP-154



DARK
BURLWOOD
WTP-231



COCOA
BURLWOOD
WTP-302



CARBON
FIBER
WTP-137



BIRDSEYE
MAPLE
WTP-371

Waldoch

Waldoch



RVIA



NTEA's Member Verification Program (MVP) recognizes eligible companies in the work truck industry for outstanding business practices and successful implementation of quality standards.

SINCE 1974



